

User Manual

SpeedyBee F745 35A BLS AIO

contents

- Part 1 - OverView**
 - Specifications 1
 - Dimensions 2
 - Package 3
 - Layout 4
- Part 2 - Flight Controller**
 - Wiring Diagram 5
 - App 6
 - FC Firmware Update 7
 - BlackBox Analyzer 8
- Part 3 - ESC**
 - Connection with Motors & Power Cable 9
 - ESC Configuration 10
 - ESC Firmware Update 11

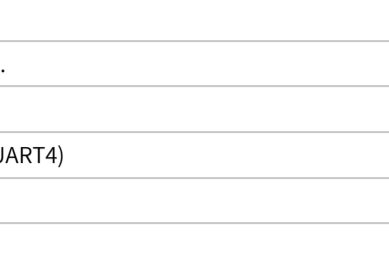

Part 1 - OverView

Specifications

1/11

Overview	
Product Name	SpeedyBee F745 35A BLS AIO
Buzzer Input	3S - 6S LiPo
Mounting	25.5 x 25.5mm, 3mm hole diameter
Dimension	36.5mm(L) x 36.5mm(W) x 7mm(H), recommended for quads at 3.5" or above
Weight	10.1g
FC	
MCU	STM32F745
IMU(Gyre)	MPU6000
USB Connection	Need to solder a USB TYPE-C module to D+,D-,GND pads.
Barometer	BMP280
OSD	Supported
BLE Bluetooth	Supported. Used for parameter configuration
Flash FC Firmware Wirelessly	Supported
Download/Analyze Blackbox	Supported
DJI Air Unit 6-pin Connector	Built-in.
Flashfor BlackBox)	8MB
Current Sensor	Supported. Scale=256
BetaFlight Camera Control Pad	Yes(CC pad)
5V Output	4 groups of 5V output. The total current load is 2.5A.
9V Output	None
3.3V Output	Supported. Up to 500mA current load.
ESC Signal Pads	M1 - M4
UART	Full UART * 4(UART1, UART2, UART3, UART4)
ESC Telemetry UART	None
IOC	Supported.
LED Pad	Used for WS2812 LED
Buzzer	BZ+ and BZ- pad used for 5V Buzzer
BOOT Button	Used to enter DFU mode
RSST Input	Not supported
SmartPort	Use any TX pad of UART for the SmartPort feature.
Supported Flight Controller	Betaflight(Default)
Firmware	SpeedyBee F745AIO
Firmware Target Name	SPEEDYBEE F745AIO
ESC	
Power Input	3-6S LiPo
Continuous Current	35A * 4
Burst Current	45A(5S)
ESC Protocol	DSHOT300/600
Power Output	VBAT
Current Sensor	Supported(Scale=256)
Firmware	BLHeli_S JH40

Dimensions

2/11

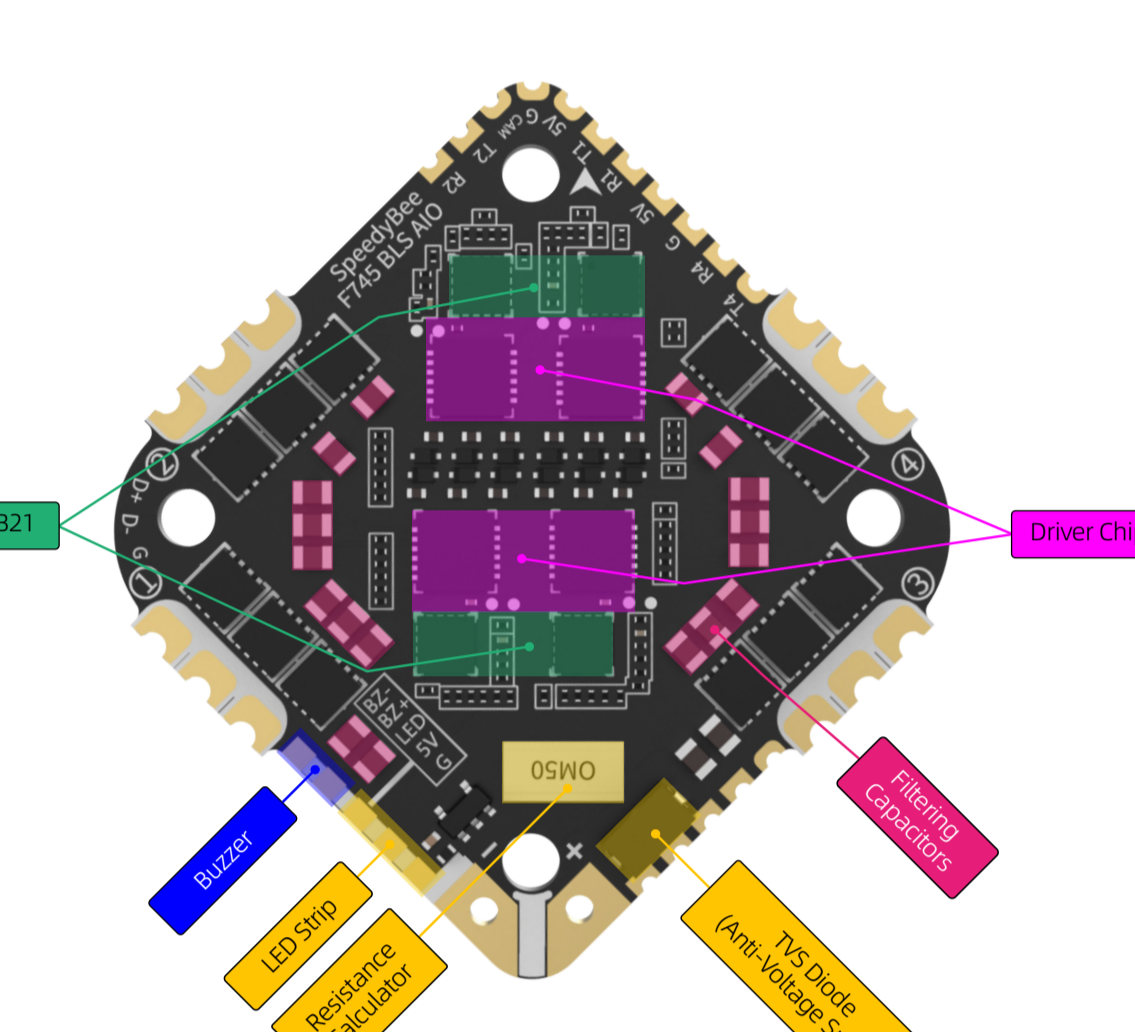

Package

3/11

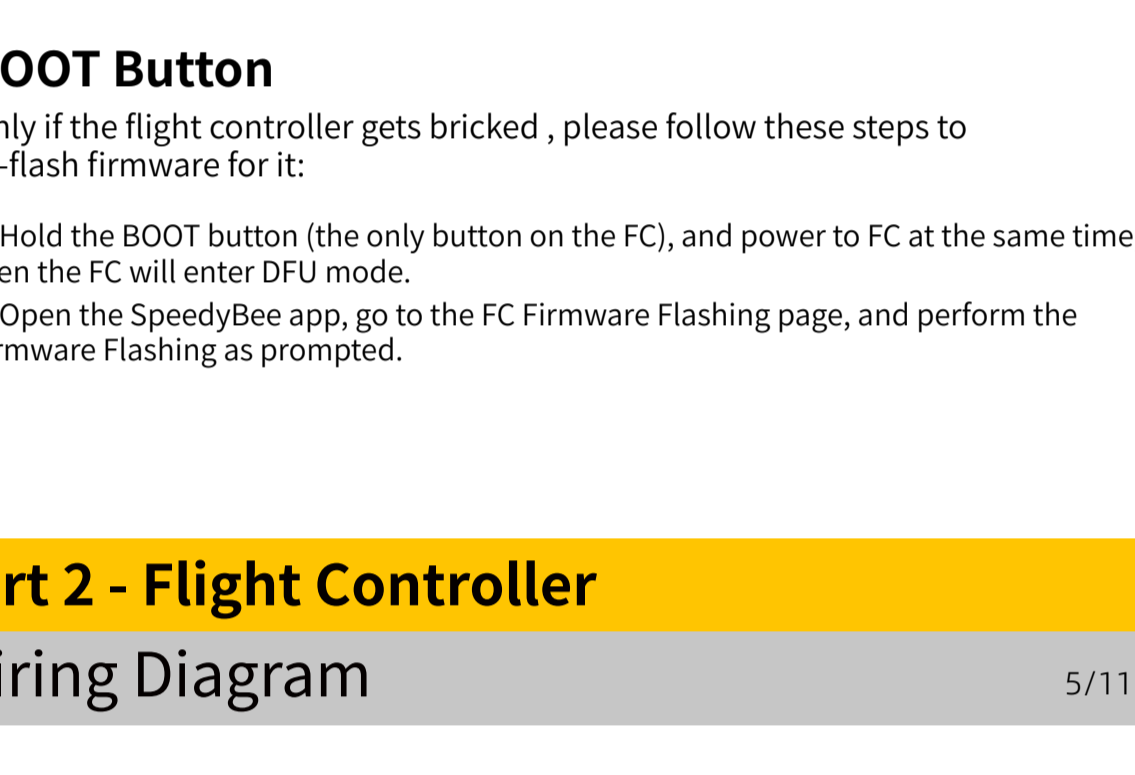

- SpeedyBee F745 35A BLS AIO x 1
- 35V 470uF Capacitor x 1
- XT30 Power Cable(Length: 7cm) x 1
- 6pin DJI Air Unit cable x 1
- External USB Port module(Wire Length: 5mm) x 1
- M2(Diameter) * 12mm(Length) Screw x 5
- M2(Hole Diameter) * 6.6mm(Height) Anti-vibration Silicone Grommets x 5
- M2 Silicone O-Ring x 5
- M2 Nylon Hex Nut x 5
- Manual & App Download Card x 1

Layout

4/11

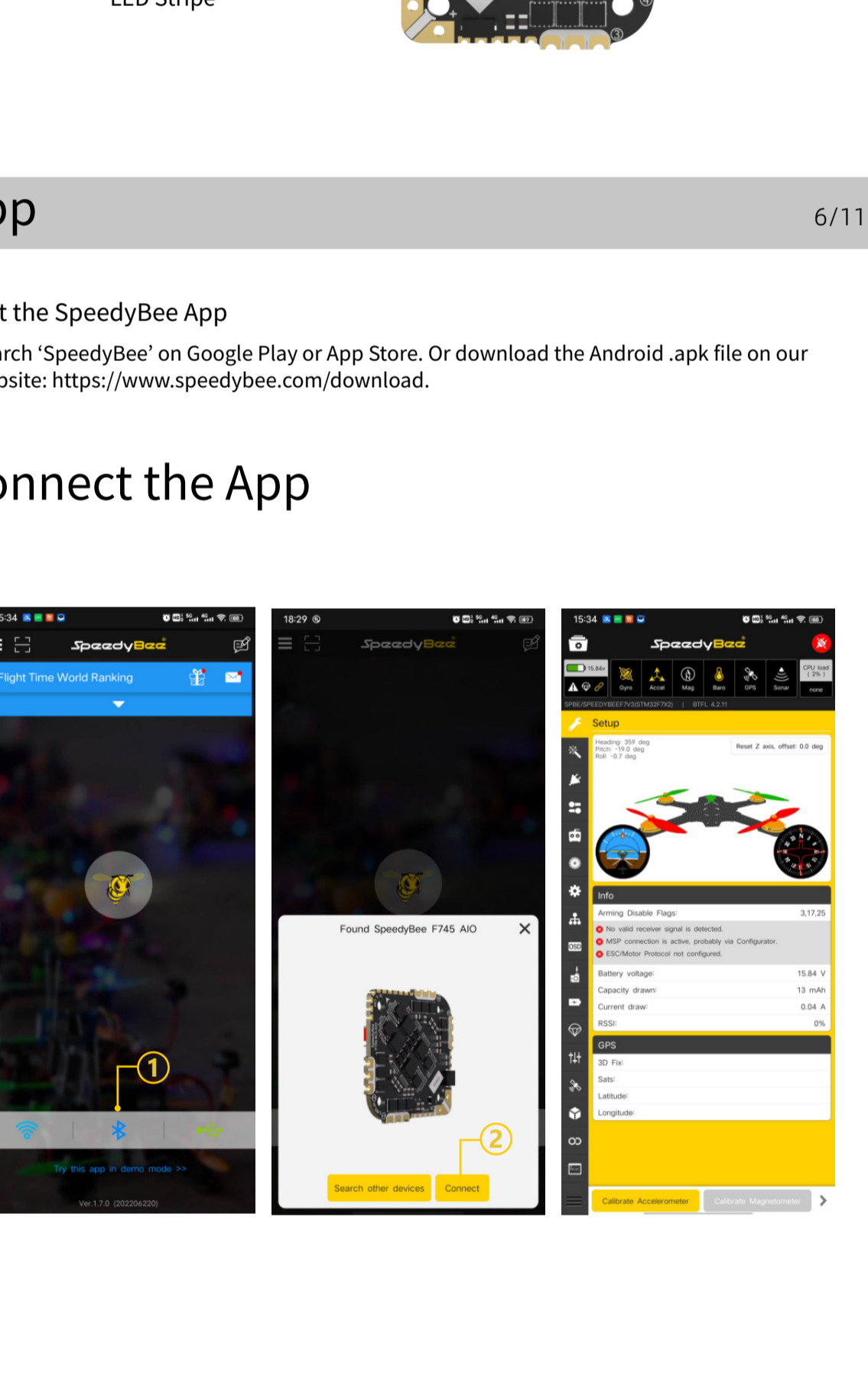

LED Indicator Definition

- GREEN LED - Solid Green indicates Bluetooth is connected.
- BLUE LED - Flight controller status light which is controlled by the flight controller firmware.

BOOT Button

Only if the flight controller gets bricked, please follow these steps to re-flash firmware for it:

1. Hold the boot button (the only button on the FC), and power to FC at the same time, then the FC will enter DFU mode.
2. Open the SpeedyBee app, go to the FC Firmware Flashing page, and perform the Firmware Flashing as prompted.

Part 2 - Flight Controller

Wiring Diagram

5/11

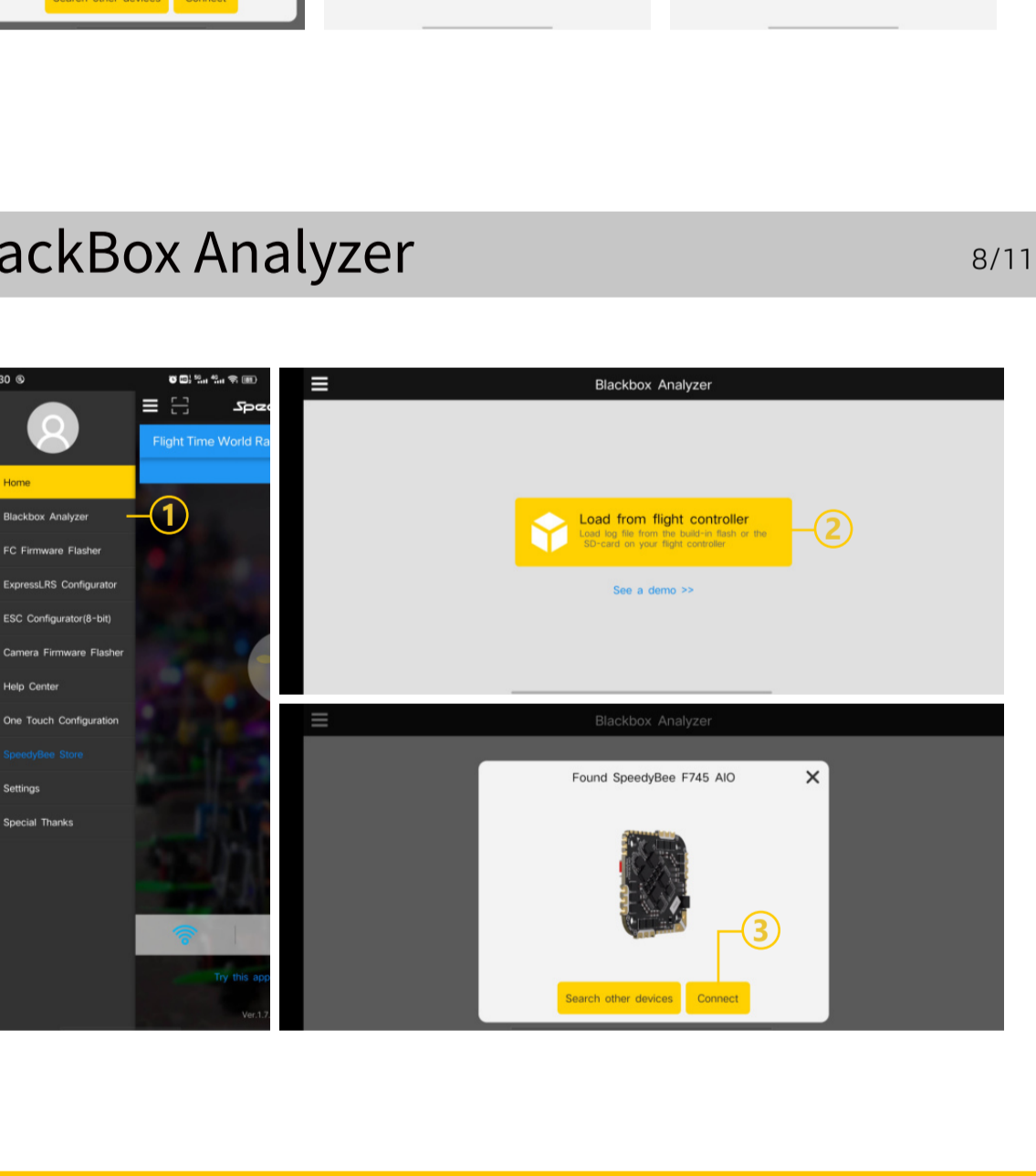

App

6/11

■ Get the SpeedyBee App
Search 'SpeedyBee' on Google Play or App Store. Or download the Android .apk file on our website: <https://www.speedybee.com/download>.

Connect the App

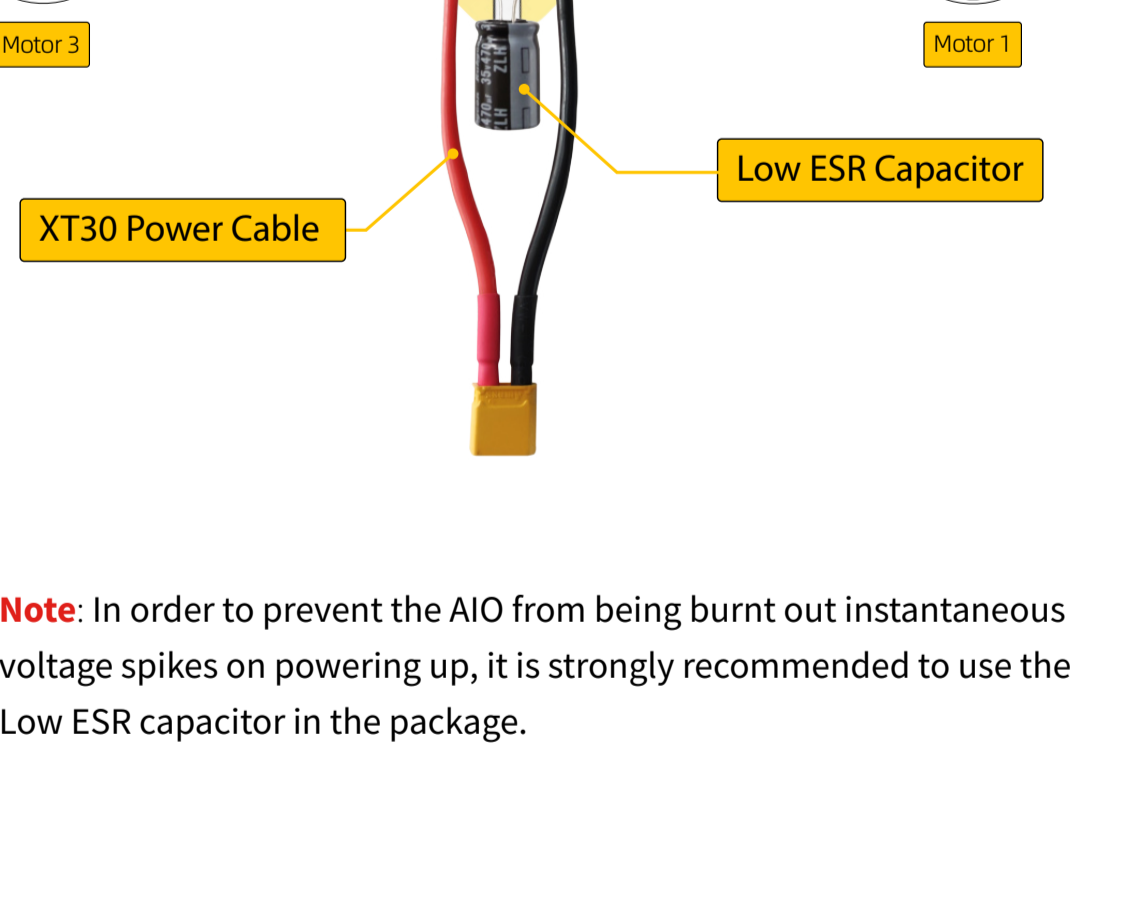

FC Firmware Update

7/11

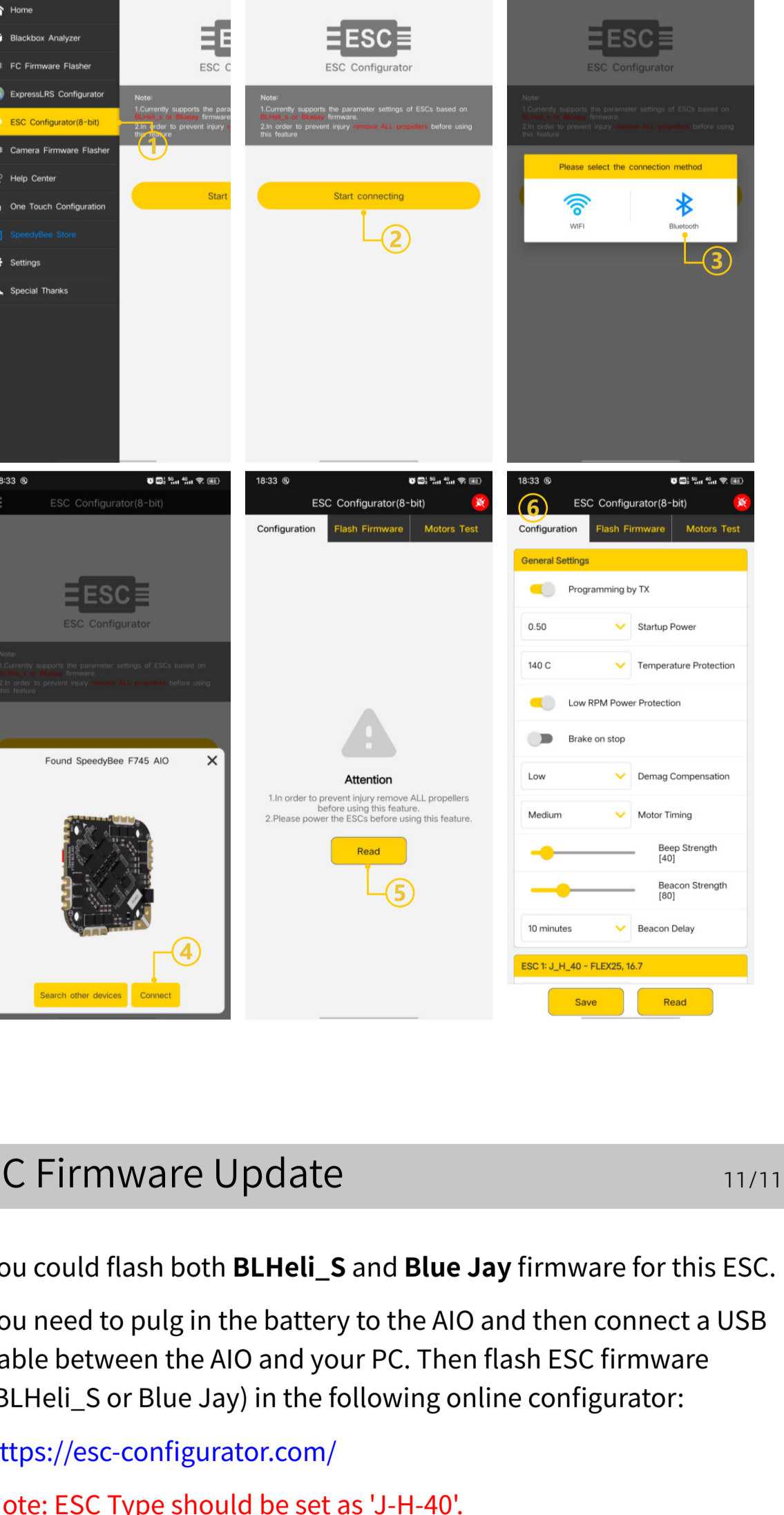

BlackBox Analyzer

8/11

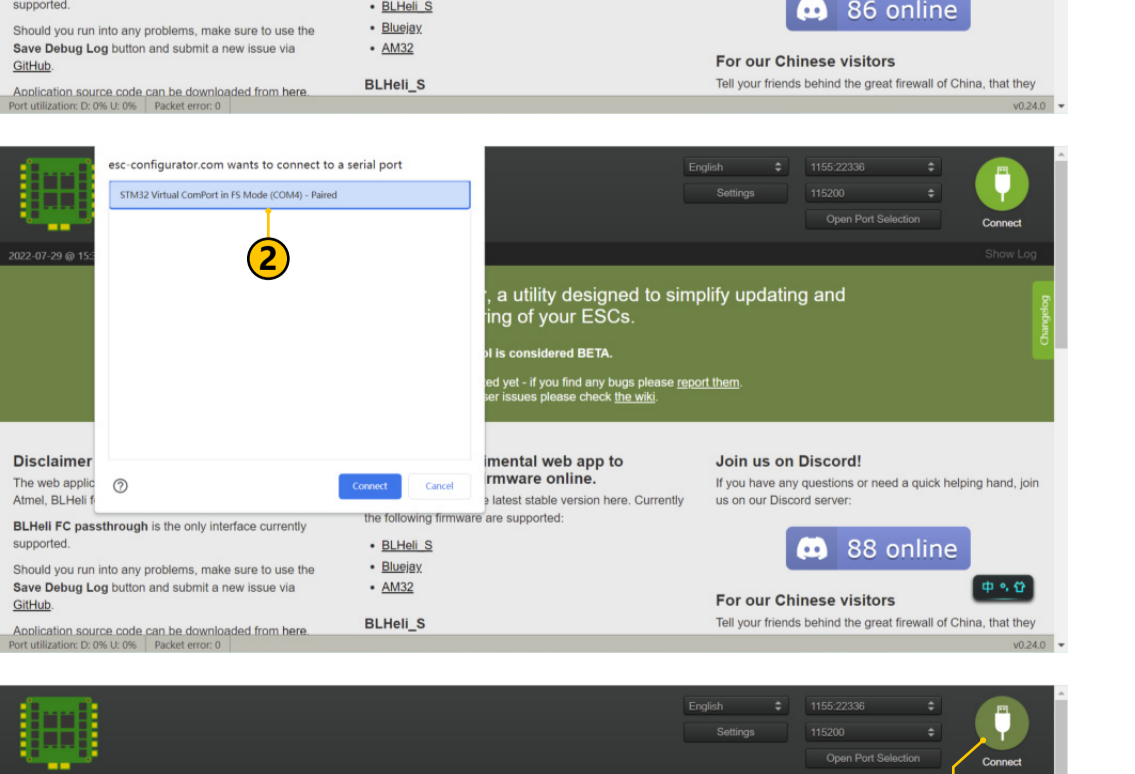

Part 3 - ESC

Connection with Motors & Power Cable

9/11

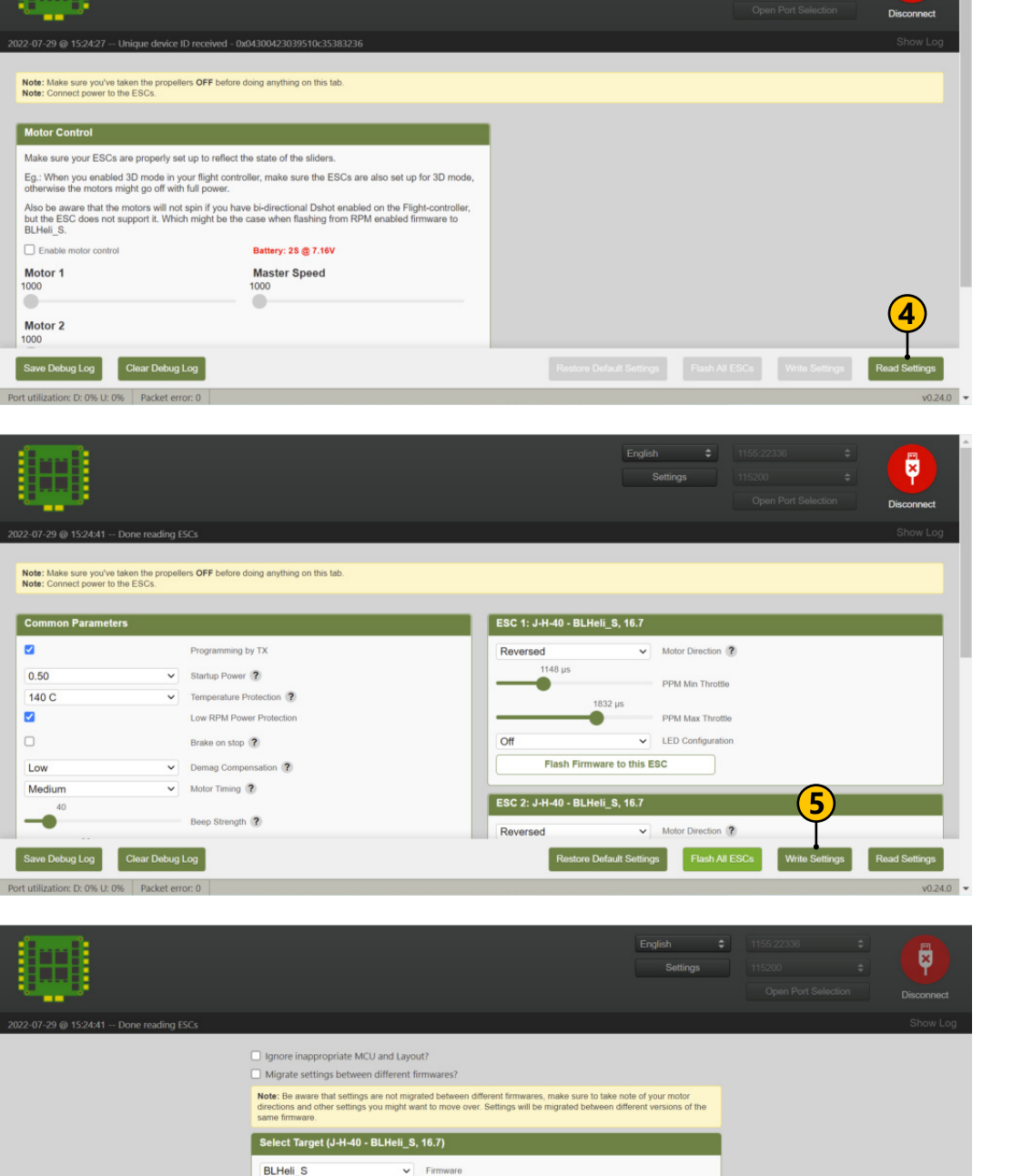

■ Note: In order to prevent the AIO from being bricked out instantaneous voltage spikes on powering up, it is strongly recommended to use the Low ESR capacitor in the package.

ESC Configuration

10/11

ESC Firmware Update

11/11

■ You could flash both BLHeli_S and Blue Jay firmware for this ESC. You need to plug in the battery to the AIO and then connect a USB cable between the AIO and your PC. Then flash ESC firmware (BLHeli_S or Blue Jay) in the following online configurator:

<https://esc-configurator.com/>

Note: ESC Type should be set as 'J-H-40'.

